

Type	FLYBACK	Size	E16	Output	5 and 12 V	MYRRA P/N	74010
------	----------------	------	------------	--------	-------------------	-----------	--------------

Product designation

FLYBACK TRANSFORMER - E16 - 5 + 12 V - 12 W

MECHANICAL CHARACTERISTICS - PINOUT

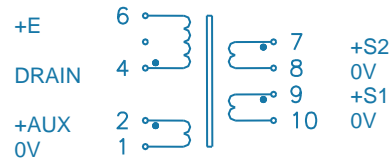
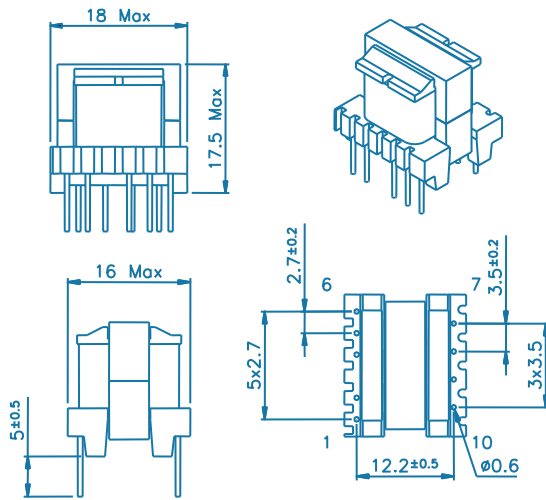

Pin 3 removed
PCB recommended drilling diameter : 1.1 mm

ELECTRICAL CHARACTERISTICS

MYRRA P/N	Maximum output power	Windings					
			Pins	Turns	Voltage	Maximum current	Inductance (+/- 10%)
74010	12.0 W	P	4 - 6	120	85 ~ 265 V _{rms}	0.55 A _{pk}	1.66 mH
		Aux.	2 - 1	14	7.0 ~ 14.0 V _{DC}	0.1 A _{DC}	
		S1	9 - 10	7	3.3 ~ 7.0 V _{DC}	0.2 A _{DC}	
		S2	7 - 8	14	8.0 ~ 17.0 V _{DC}	1.0 A _{DC}	

REMARKS

RoHS compliant

UL94 V-0 materials

Class B

Ambient temperature: 50 °C max.

P / S :

Creepage distances ≥ 6.0 mm

4.0 kV dielectric test

Construction conforms to IEC60950, IEC60335 and IEC61558-2-16 for reinforced isolation